

## Serie ZAT primär getaktet für Trageschienenmontage

Stromversorgung und Batterielader für Industrie- und Telekom-Anwendung  
Ausgangsleistung 60W, 120W, 250W  
temperaturgeführte Ladespannung



**Eingang:**  
Eingangswechselspannung 60W 90-264V 45-65Hz  
120W 230/115V 45-65Hz  
250W 230/115V 45-65Hz

**Ausgang:**  
Ausgangsgleichspannung 12V...48V  
Ausgangsleistung siehe Tabelle  
Netzausfallüberbrückung 60W > 50ms  
120W > 20ms  
250W > 20ms  
Wirkungsgrad 82% - 90%

**Regeldaten:**  
Netzausregelung < 0,15%  
U<sub>in</sub> min...U<sub>in</sub> max  
Lastausregelung < 0,5% - 1,0%  
ohne Entk.-diode

**Betriebsgrößen:**  
Betriebstemperaturbereich -40°C - +70°C  
Leistungsreduzierung ab + 55°C  
12V 250W ab + 45°C  
Kühlung Konvektion

**Sicherheit:**  
Elektrische Sicherheit EN60950-1 class 1, UL508  
Prüfspannung prim. - sek.: 3,00 kV<sub>eff</sub>  
prim. - Masse: 1,5 kV<sub>eff</sub>  
sek. - Masse: 500V DC

### Abmessungen:

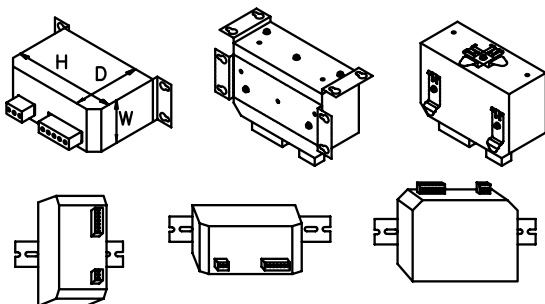

	60W	125W	250W
Breite (W)	51 mm	66 mm	75 mm
Höhe (H)	121 mm	148 mm	173 mm
Tiefe (D)	81 mm	113 mm	122 mm

**EMV:**  
Störaussendung EN61000-6-3  
Störfestigkeit EN61000-6-2

**Steuer-, Bedien- und Anzeigeelemente:**  
Betriebsanzeige LED, grün  
Einstellung Spannung mit: Potentiometer  
Melderelais siehe Standard features/Option

Elektrische Anschlüsse 2,5mm<sup>2</sup> Schraubklemme

**Mechanik und Gewicht:**  
Abmessungen 60W 51x121x81mm (BxHxT)  
120W 66x148x113mm (BxHxT)  
250W 75x173x122mm (BxHxT)  
Gewicht 60W 360g  
120W 840g  
250W 1,5kg

Gehäuse IP20, Stahl/Aluminium

**Montage:**  
Befestigung DIN Schiene TS35

### Leistungsreduzierung

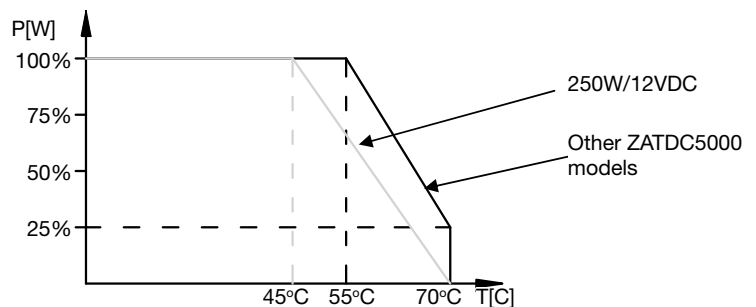

**Bestellbezeichnung:**



**Standard features:**

- 60W 1 Melderelais
- 3 Melderelais und Entkoppeldiode
- 120/250W 1 Melderelais und OVP
- 3 Melderelais und Entkoppeldiode und OVP

**Option:**

- 60W 0 shut down
- 2 shut down und OVP
- 120/250W 0 Melderelais und shut down
- 2 Entkoppeldiode, Melderelais, shut down
- 4 output remote control for battery test, Melderelais, OVO, Entkoppeldiode

Typ	UA / IA	Watt	Eingangsspannung		
Stromversorgung			230/115VAC	90..264VAC	PFC
ZAT 12/5/_/_	12V5A	60		X	
ZAT 24/2,5/_/_	24V2,5A	60		X	
ZAT 36/1,7/_/_	36V1,7A	60		X	
ZAT 48/1,25/_/_	48V1,7A	60		X	
ZAT 12/10/_/_	12V10A	120	X		
ZAT 24/5/_/_	24V5A	120	X		
ZAT 48/2,5/_/_	48V2,5A	120	X		
ZAT 12V18/_/_	12V18A	240	X		X
ZAT 24/10/_/_	24V10A	240	X		X
ZAT 48/5/_/_	48V5A	240	X		X
Batterie-Lader					
ZAT 13,7/4,4/_/_	13,7V4,4A	60		X	
ZAT 27,4/2,2/_/_	27,4V2,2A	60		X	
ZAT 41, 1/1,5/_/_	41,1V1,5A	60		X	
ZAT 54,8/1,1/_/_	54,8V1,1A	60		X	
ZAT 13,7/10/_/_	13,7V10A	137	X		
ZAT 27,4/5/_/_	27,4V5A	137	X		
ZAT 54,8/2,5/_/_	54,8V2,5	137	X		
ZAT 13,7/18/_/_	13,7V18A	274	X		X
ZAT 27,4/10/_/_	27,4V10A	274	X		X
ZAT 54,8/5/_/_	54,8V5A	274	X		X

**Anwendungsbeispiele:**

Battery back-up systems  
 Temperature compensated charging  
 Low voltage disconnecting unit

Special features with external control:

- Boost charging
- Battery test possibility
- Shut down by external 4-15V voltage
- Controllable output voltage

Parallel connection with output series diode and module fail alarm

Series connection ± Outputs

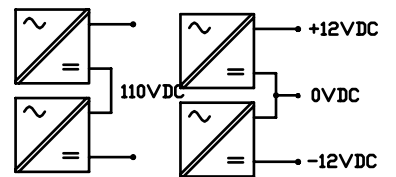
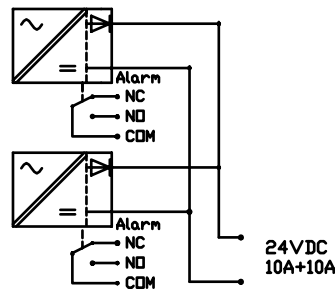
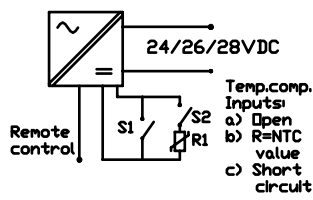
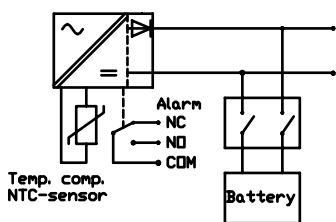

## PIN Configuration 60W Models:

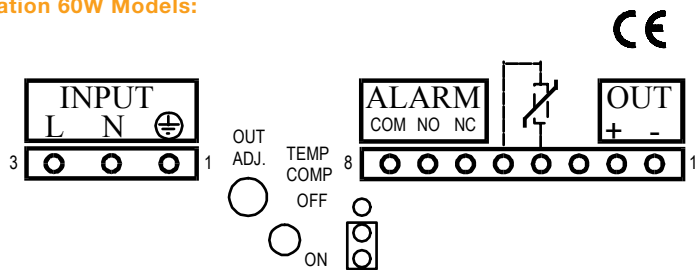

### INPUT CONNECTOR

- 1: Protective Earth
- 2: N (+ if used at DC network)
- 3: L (- if used at DC network)

### OUTPUT CONNECTOR

- 1: Output -
- 2: Output +
- 3: Not in use (Y selection code 1 or 3) OR Remote control input in shut down models (Y selection code 0 or 2)
- 4,5: Temperature compensation NTC sensor
- 6: Alarm relay, normally closed (relay not energized)
- 7: Alarm relay, normally open (relay not energized)
- 8: Alarm relay, common

Use 60/70 or 75°C copper (CU) wire only. The recommended terminal tightening torque is 0.5Nm.

## PIN Configuration 125W Models:

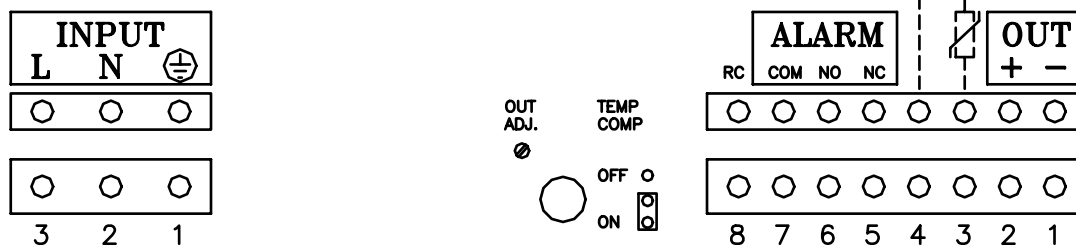

### INPUT CONNECTOR

- 1: Protective Earth
- 2: N
- 3: L

### OUTPUT CONNECTOR

- 1: Output -
- 2: Output +
- 3,4: Temperature compensation NTC sensor
- 5: Alarm relay, normally closed (relay not energized)
- 6: Alarm relay, normally open (relay not energized)
- 7: Alarm relay, common
- 8: Not in use (Y selection code 1 or 3) OR Remote control input in shut down (Y=0 or 2) or battery test models (Y=4 or 5)

Use 60/70 or 75°C copper (CU) wire only. The recommended terminal tightening torque is 0.5Nm.

## PIN Configuration 250W Models:

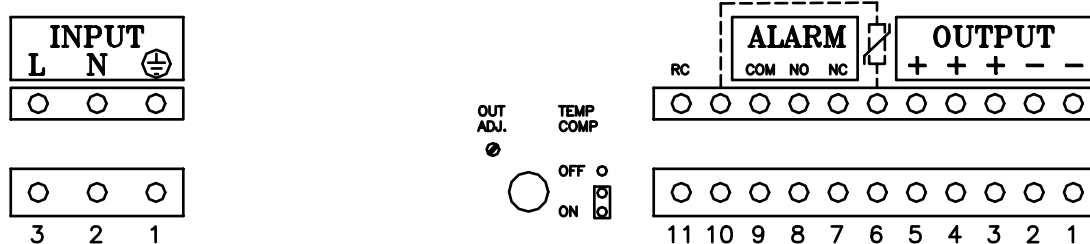

### INPUT CONNECTOR

- 1: Protective Earth
- 2: N
- 3: L

### OUTPUT CONNECTOR

- 1, 2: Output - Note: Rated current 12A / pin
- 3, 4, 5: Output + Note: Rated current 12A / pin
- 6: Temperature compensation NTC sensor
- 7: Alarm relay, normally closed (relay not energized)
- 8: Alarm relay, normally open (relay not energized)
- 9: Alarm relay, common
- 10: Temperature compensation NTC sensor
- 11: Not in use (Y selection code 1 or 3) OR Remote control input, shut down (Y=0 or 2) or battery test (Y=4 or 5) models

Use 60/70 or 75°C copper (CU) wire only. The recommended terminal tightening torque is 0.5Nm.

## 115/230V INPUT VOLTAGE SELECTION

### 125/250W models:

The unit is factory set to operate with a 230V nominal input voltage. The nominal input voltage can be selected via the internal 115/230 voltage selector on the PCB. Access to the selector is through the ventilation holes of the unit cover. **Always disconnect power before selecting.**

### 60W models:

The unit is wide input type and will work without modification from 90VAC to 264VAC.

## USING UNIT WITH DC INPUT

60W units can be operated also by DC input voltage. See voltage range from specification and connection from pin configuration.

## OUTPUT VOLTAGE ADJUSTMENT

The output voltage of the module can be adjusted with the multi-turn potentiometer located on the front panel. All models can be used either as a power supply or a charger by correct adjustment.

125W and 250W models: Maximum output current is available within the full voltage adjustment range.

60W models: Maximum output power is available within the full voltage adjustment range

## ALARM RELAY

The potential free alarm output indicates if the output of the unit is healthy. Alarm relay contacts, both normally open and normally closed, are presented on the unit connector. If the output is healthy, the NO and COM pins are short circuited. If the unit fails the relay contacts will changeover and NC and COM pins will be short circuited. Word "normal" in relay pins means that mode when relay is not energized.

## SERIES / PARALLEL CONNECTION

Reserve 2cm space on both sides for proper cooling.

Parallel operation: Do not chain the outputs, rated current 12A / pin. Recommended cable size: 2.5mm<sup>2</sup>, length > 0.5m for optimum load sharing.

Series operation: Up to 500V total voltage.

## TEMPERATURE COMPENSATION

Temperature compensated charging provides the optimum float charge voltage when batteries are being used. To utilize this feature it is necessary to install a NTC sensor across the temperature compensation pins on the output connector. It is also necessary to set the jumper on the front panel to ON position. The output voltage should be adjusted when the jumper is in the OFF position. This will simulate room temperature and ensure accuracy.

The recommended sensor type is a 2.2k ohm NTC resistor, e.g. Epcos B57164-K222-K. The sensor should be installed local to the batteries. The sensor is galvanically connected to the + output. Temperature compensation sensor is included in charger models (x =7, 8 or 9) delivery

## LED

A green LED indicates that the output of the module is healthy.

## OUTPUT OVERCURRENT PROTECTION

Automatic, self-resetting electronic current limiting is included and the output is short circuit proof.

## OUTPUT OVER VOLTAGE PROTECTION (OPTION)

Output of the unit will shut down if the output voltage rises above protection level. (16Volts/12V models, 31Volts/24V models and 58 Volts/48V models). Protection must be manually resetted by disconnecting the AC main voltage.

## OUTPUT VOLTAGE REMOTE SHUT DOWN AND BATTERY TEST OPTIONAL MODELS

Output of the unit will shut down, when a +4...15VDC signal is applied to the remote control input (RC) with reference to negative output.

In battery test models output voltage drops 15-25% , when a +4...15VDC signal is applied to the RC pins as above.

The output voltage will return to the original level, when +4...15VDC signal is removed from RC pins.

## INTERNAL OUTPUT SERIES DIODE (OPTION)

The internal diode is placed in series with the positive output. The benefits of having the diode fitted are:

- Improved redundancy if the modules are connected in parallel (not for 60W models)
- Power OK signal and LED work independently regardless battery or parallel connections
- The parallel connected modules can be Hot Plug replaced without the system output power interruption
- The reverse current bleed is low if a battery is connected to the output of the charger

The disadvantages of having the diode fitted are lower efficiency, deration to the output voltage regulation and load sharing.

Note: The output series diode does not protect against reverse polarity connection of the battery.

## WARNING!

Dangerous voltages, capable of causing death, are present in this equipment. Do not remove the cover. No operator serviceable parts inside. Refer servicing to qualified service personnel.